

DISCHARGING

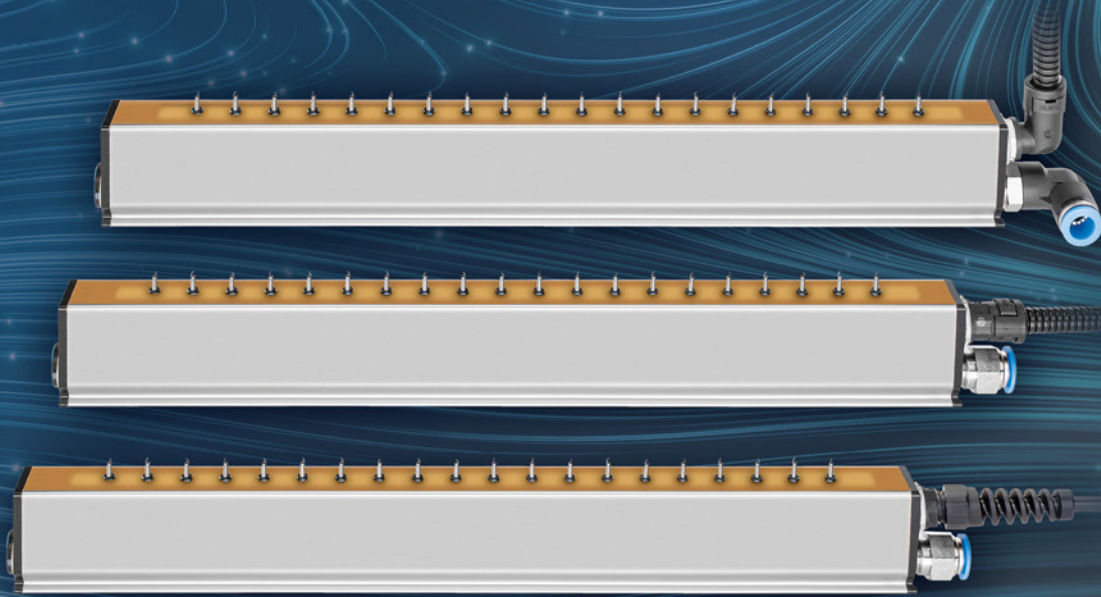

eltex

electrostatic
innovations



flexBAR R60L

HIGH-END discharge for ultimate discharge performance

The flexBAR R60L with freestanding, air-supported spring tips offers a very high passive discharge efficiency, allowing active operation even at low level of AC high voltage. A small amount of air can be blown through the hollow spring tip to increase the range.

Advantages at a glance

- › excellent discharge performance at close and wide range
- › variable use in tight, grounded machine spaces
- › high discharge performance due to patented spring tip
- › reduced dirt adhesion due to optional air circulation around the spring tips
- › no health hazards in case of electric shocks when touching individual tips (≤ 10 tips)

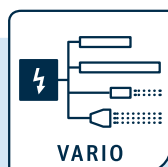

VARIO

Suitable for connecting
one or more Eltex
discharge components:



POWER IONIZER



BASE IONIZER ES60



COMPACT IONIZER ES24



flexBAR R60L

Technical Information

Bar element	aluminum with special coating
Encapsulation material	polyurethane, UL-94 V-0
Emission tips	stainless steel, flexible
Installation material	glas fiber reinforced plastic bracket
Operating ambient temperature.	0 ... +80 °C
Ambient humidity	max. 70 % RH, non-dewing
Available active lengths	15 – 2715 mm in 30 mm steps
Dimensions	20 x 45 mm, max. length: 2785 mm
Weight	approx. 1,6 kg/m
Operating voltage	max. 5 kV AC
High voltage connection	axial or radial (300° rotatable)
Short circuit current/tip	max. 0,046 mA
Contact protection	according to EN 61140
Compressed air	
Air connection	quick plug coupling NW10
Pressure	max. 1 bar
Air consumption per meter	
0.1 bar single-sided	1.1 Nm ³ /h
0.2 bar single-sided	2.,2 Nm ³ /h
0.1 bar double-sided	1.95 Nm ³ /h
0.2 bar double-sided	3.8 Nm ³ /h

Mounting options

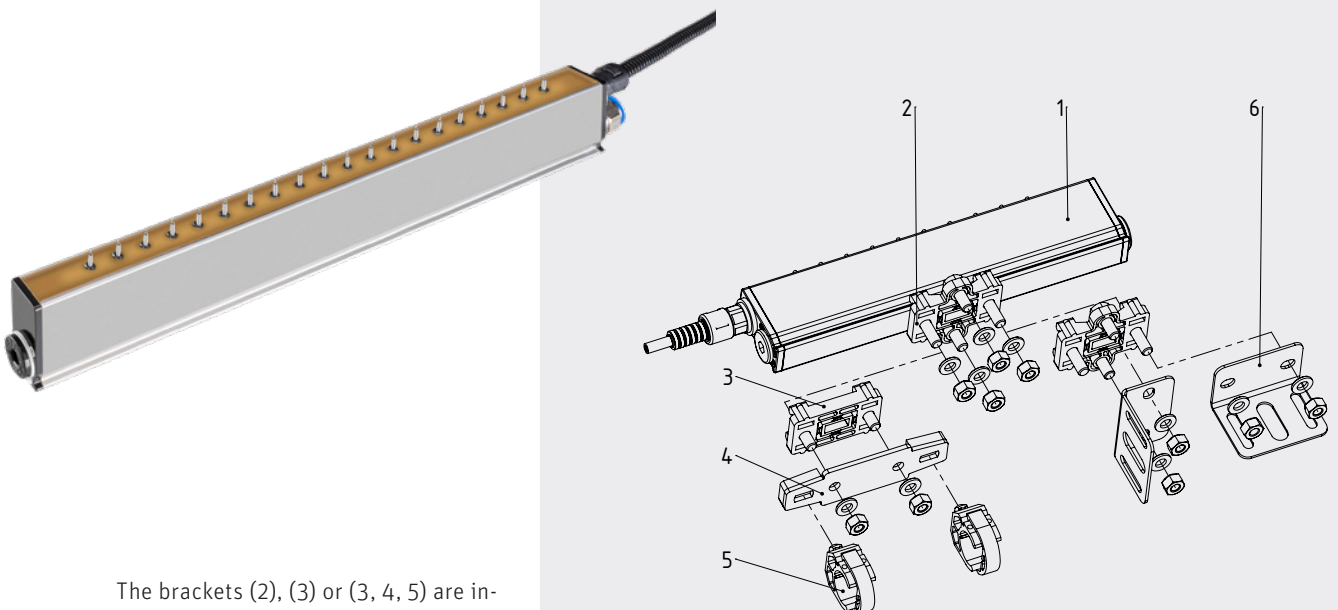

The brackets (2), (3) or (3, 4, 5) are included in the standard scope of delivery depending on the configuration. The brackets (6) can be ordered separately.



flexBAR R60L

Dimensions

Attachment clips

Scope of delivery related to total length

up to 1 m: 2 pieces / bar

up to 2 m: 3 pieces / bar

up to 3 m: 4 pieces / bar

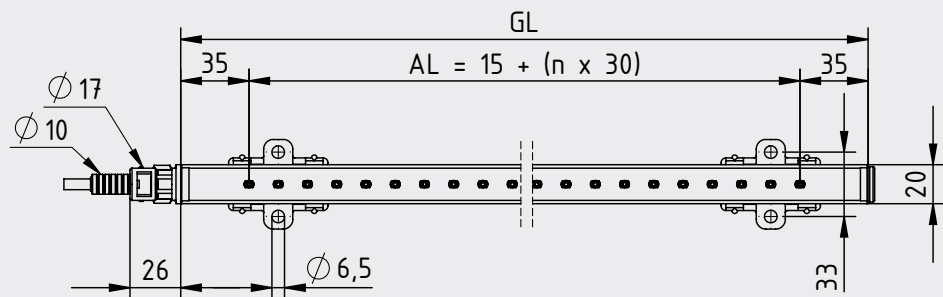
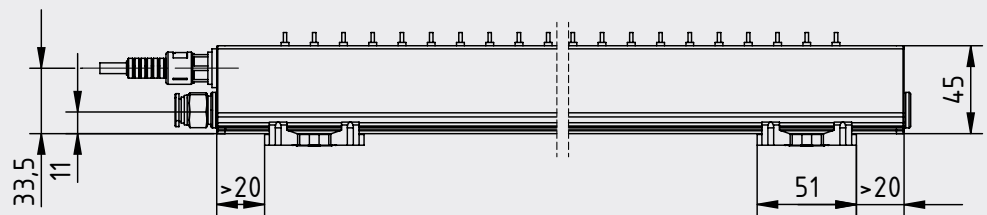
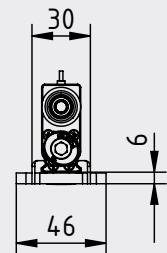

GL = total length

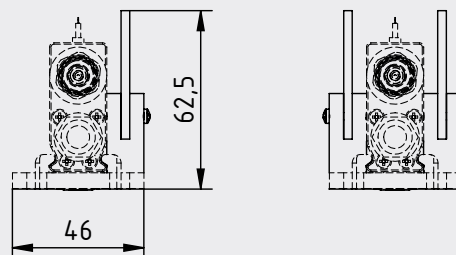

Protection profile (optional)

Protective strip on one or both sides
to protect the spring tip